

## Hermetic, 50 mil Pitch, Leadless Thin Film Chip Resistor, Surface Mount Network

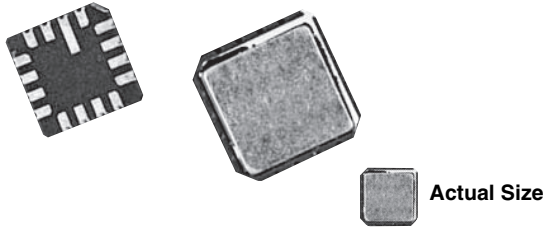

Vishay Dale Thin Film offers a wide resistance range in 16, 20, and 24 terminal hermetic leadless chip carriers. The standard circuits in the ohmic ranges listed below will utilize the outstanding wraparound terminations developed for chip resistors. Should one of the standards not fit your application, consult the applications engineering group as we may be able to meet your requirements.

### FEATURES

- High purity alumina substrate for high power dissipation
- Leach resistant terminations with nickel barrier
- 16, 20, 24 terminal gold plated wraparound true hermetic packaging
- Military/aerospace
- Hermetically sealed
- Isolated/bussed circuits
- Ideal for military/aerospace applications
- Material categorization: for definitions of compliance please see [www.vishay.com/doc?99912](http://www.vishay.com/doc?99912)



### Note

\* This datasheet provides information about parts that are RoHS-compliant and / or parts that are non-RoHS-compliant. For example, parts with lead (Pb) terminations are not RoHS-compliant. Please see the information / tables in this datasheet for details.

### TYPICAL PERFORMANCE

TCR	ABSOLUTE	TRACKING
	25	5
TOL.	ABSOLUTE	RATIO
	0.1	NA

### Note

- Resistance range: Noted on schematics.

### SCHEMATIC

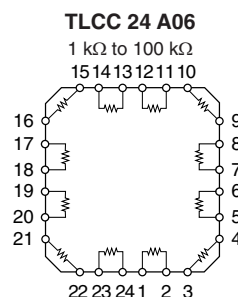
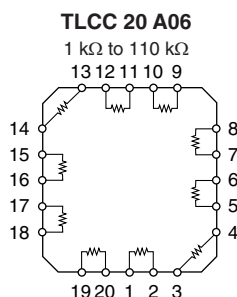
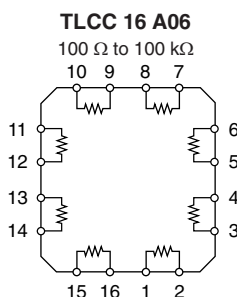
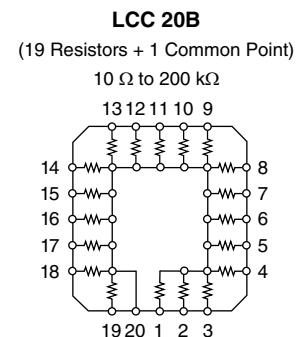
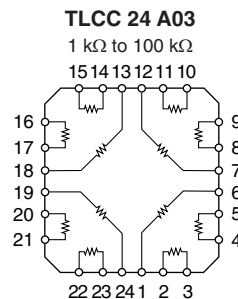
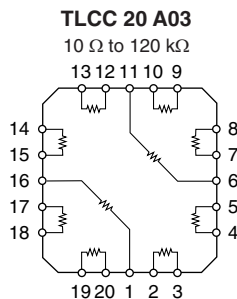
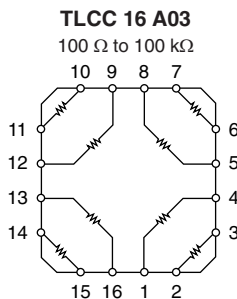
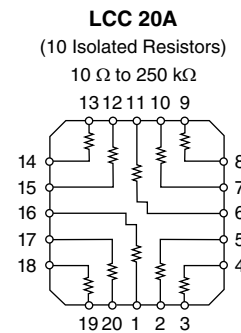
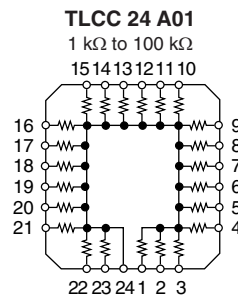
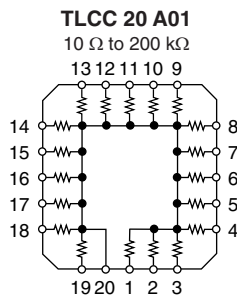
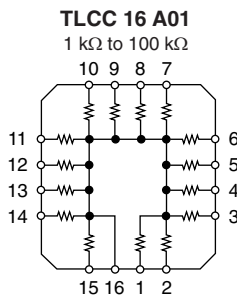

STANDARD ELECTRICAL SPECIFICATIONS		
TEST	SPECIFICATIONS	CONDITIONS
Material	Passivated nichrome	-
Pin/Lead Number	16, 20, 24	-
Resistance Range	10 $\Omega$ to 250 k $\Omega$ per resistor	-
TCR: Absolute	$\pm 25$ ppm/ $^{\circ}$ C to $\pm 300$ ppm/ $^{\circ}$ C	-55 $^{\circ}$ C to +125 $^{\circ}$ C
TCR: Tracking	$\pm 5$ ppm/ $^{\circ}$ C	-55 $^{\circ}$ C to +125 $^{\circ}$ C
Tolerance: Absolute	$\pm 0.1$ % to $\pm 1.0$ %	+25 $^{\circ}$ C
Tolerance: Ratio	N/a	-
Power Rating: Resistor	50 mW max. = common circuits 100 mW max. = isolated circuits	Maximum at +70 $^{\circ}$ C
Power Rating: Package	500 mW	Maximum at +70 $^{\circ}$ C
Stability: Absolute	$\Delta R \pm 0.05$ %	2000 h at +70 $^{\circ}$ C
Stability: Ratio	-	-
Voltage Coefficient	< 5 ppm/V (typical)	-
Working Voltage	100 V max. not to exceed $\sqrt{P \times R}$	-
Operating Temperature Range	-55 $^{\circ}$ C to +125 $^{\circ}$ C	-
Storage Temperature Range	-55 $^{\circ}$ C to +150 $^{\circ}$ C	-
Noise	< -30 dB	-
Thermal EMF	0.008 $\mu$ V/ $^{\circ}$ C	-
Shelf Life Stability: Absolute	$\Delta R \pm 0.01$ %	1 year at + 25 $^{\circ}$ C
Shelf Life Stability: Ratio	-	-

**Note**

- Tantalum nitride film is custom, consult factory.

DIMENSIONS in inches and millimeters						
DIMENSION	16 PINS		20 PINS		24 PINS	
	INCHES	MILLIMETERS	INCHES	MILLIMETERS	INCHES	MILLIMETERS
A	0.050	1.27	0.050	1.27	0.050	1.27
B	0.300	7.26	0.350	8.89	0.400	10.16
C	0.300	7.26	0.350	8.89	0.400	10.16
D	0.077	1.96	0.077	1.96	0.077	1.96
E	0.025	0.635	0.025	0.635	0.025	0.635
F	0.050	1.27	0.050	1.27	0.050	1.27
G	0.040	1.02	0.040	1.02	0.040	1.02
H	0.020	0.508	0.020	0.508	0.020	0.508



MECHANICAL SPECIFICATIONS	
Resistive Element	Passivated nichrome
Substrate Material	Alumina
Body	Ceramic
Terminals	Gold over nickel
Marking Resistance to Solvents	Per MIL-PRF-83401
Tin Lead Option	Sn63
Lead (Pb)-free Option	96.5 % Sn, 3.0 % Ag, 0.5 % Cu
Tin Lead and Lead (Pb)-free	Hot solder dip

GLOBAL PART NUMBER INFORMATION																	
New Global Part Numbering: TLCC20AE1002BUF																	
T	L	C	C	2	0	A	E	1	0	0	2	B	U	F			
T	L	C	C	T	1	6	A	0	1	K	1	0	0	3	K	U	F
GLOBAL MODEL (4 or 5 digits)	TERMINAL COUNT <sup>(1)</sup>	SCHEMATICS (4 or 5 digits)	TCR CHARACTERISTICS	RESISTANCE	TOLERANCE	PACKAGING											
<b>LCC</b> (Tin lead)	20	<b>A</b> = Isolated resistors <b>B</b> = Resistor to common bus	<b>E</b> = 25 ppm/°C <b>H</b> = 50 ppm/°C <b>K</b> = 100 ppm/°C <b>M</b> = 300 ppm/°C	First 3 digits are significant figures and the last digit specifies the number of zeros to follow.  Example: 10R0 = 10 Ω 12R5 = 12.5 Ω 1000 = 100 Ω 1001 = 1000 Ω	<b>B</b> = 0.1 % <b>D</b> = 0.5 % <b>F</b> = 1 % <b>G</b> = 2 % <b>J</b> = 5 % <b>K</b> = 10 % <b>S</b> = Special	<b>TAPE AND REEL</b> <b>T0</b> = 100 min., 100 mult <b>T1</b> = 1000 min., 1000 mult <b>T3</b> = 300 min., 300 mult <b>T5</b> = 500 min., 500 mult <b>TF</b> = Full reel 2000 <b>TS</b> = 100 min., 1 mult  <b>UF</b> = TUBED											
<b>LCCT</b> (Lead (Pb)-free) (e1)	20																
<b>TLCC</b> (Tin lead)	16 20 24	<b>A01</b> = Resistor to common bus <b>A03</b> = Isolated parallel resistor <b>A06</b> = Isolated adjacent resistor															
<b>TLCCCT</b> (Lead (Pb)-free) (e1)	16 20 24																
<b>Historical Part Number example: LC20BK1003J (for reference purposes only)</b>																	
<b>LC</b>	<b>20</b>	<b>B</b>	<b>K</b>	<b>1003</b>	<b>J</b>												
SERIES	PINS	SCHEMATIC	TCR CHARACTERISTIC	RESISTANCE	TOLERANCE												

**Note**

<sup>(1)</sup> LCC or LCCT only available in 20 pin size.



## **Disclaimer**

ALL PRODUCT, PRODUCT SPECIFICATIONS AND DATA ARE SUBJECT TO CHANGE WITHOUT NOTICE TO IMPROVE RELIABILITY, FUNCTION OR DESIGN OR OTHERWISE.

Vishay Intertechnology, Inc., its affiliates, agents, and employees, and all persons acting on its or their behalf (collectively, "Vishay"), disclaim any and all liability for any errors, inaccuracies or incompleteness contained in any datasheet or in any other disclosure relating to any product.

Vishay makes no warranty, representation or guarantee regarding the suitability of the products for any particular purpose or the continuing production of any product. To the maximum extent permitted by applicable law, Vishay disclaims (i) any and all liability arising out of the application or use of any product, (ii) any and all liability, including without limitation special, consequential or incidental damages, and (iii) any and all implied warranties, including warranties of fitness for particular purpose, non-infringement and merchantability.

Statements regarding the suitability of products for certain types of applications are based on Vishay's knowledge of typical requirements that are often placed on Vishay products in generic applications. Such statements are not binding statements about the suitability of products for a particular application. It is the customer's responsibility to validate that a particular product with the properties described in the product specification is suitable for use in a particular application. Parameters provided in datasheets and / or specifications may vary in different applications and performance may vary over time. All operating parameters, including typical parameters, must be validated for each customer application by the customer's technical experts. Product specifications do not expand or otherwise modify Vishay's terms and conditions of purchase, including but not limited to the warranty expressed therein.

Except as expressly indicated in writing, Vishay products are not designed for use in medical, life-saving, or life-sustaining applications or for any other application in which the failure of the Vishay product could result in personal injury or death. Customers using or selling Vishay products not expressly indicated for use in such applications do so at their own risk. Please contact authorized Vishay personnel to obtain written terms and conditions regarding products designed for such applications.

No license, express or implied, by estoppel or otherwise, to any intellectual property rights is granted by this document or by any conduct of Vishay. Product names and markings noted herein may be trademarks of their respective owners.