

(2,54mm) .100"

IDSS, IDSD, IDMS, IDMD SERIES

SLIM BODY FLAT RIBBON IDC CABLES

SPECIFICATIONS

IDSS, IDSD

For complete specifications see www.samtec.com?IDSS or www.samtec.com?IDSD

Insulator Material:

Black Glass Filled Polyester



Plating:

Au over 50µ" (1,27µm) Ni or Sn over 100µ" (2,54µm) Cu or 50µ" (1,27µm) Ni

Wire:

28 AWG 7/36 stranded Tinned Copper

Temperature Range:

-20°C to +105°C (Rainbow Cable)
-40°C to +105°C (Gray Cable)

Contact:

BeCu

Current Rating:

1A

Contact Resistance:

10 mΩ max

Lead Size Range:

(0,56mm) .022" SQ to (0,71mm) .028" SQ

Lead Insertion Depth:

(5,59mm) .220" to (6,22mm) .245"

Insertion Force:

(Single contact only)

4oz avg.

((0,64mm) .025" SQ probe)

Withdrawal Force:

(Single contact only)

3oz avg.

((0,64mm) .025" SQ probe)

RoHS Compliant: Yes

SPECIFICATIONS

IDMS, IDMD

For complete specifications see www.samtec.com?IDMS or www.samtec.com?IDMD

Insulator Material:

Black Glass Filled Polyester



Plating:

Au over 50µ" (1,27µm) Ni or Sn over 100µ" (2,54µm) Cu or 50µ" (1,27µm) Ni

Wire:

28 AWG 7/36 stranded Tinned Copper

Temperature Range:

-20°C to +105°C (Rainbow Cable)
-40°C to +105°C (Gray Cable)

Terminal:

Phosphor Bronze

Current Rating:

1A

RoHS Compliant: Yes

Note:

This Series is non-standard, non-returnable.

Mates with: TSW, MTSW, TSM, EJH

IDSD Mates with: TST, HTST, ZST

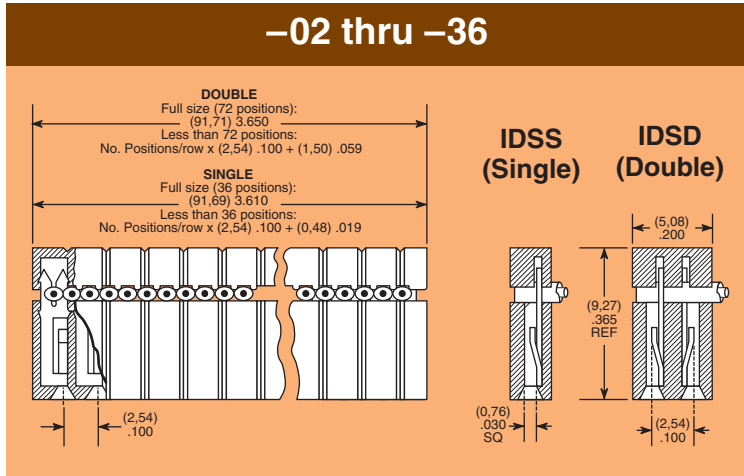
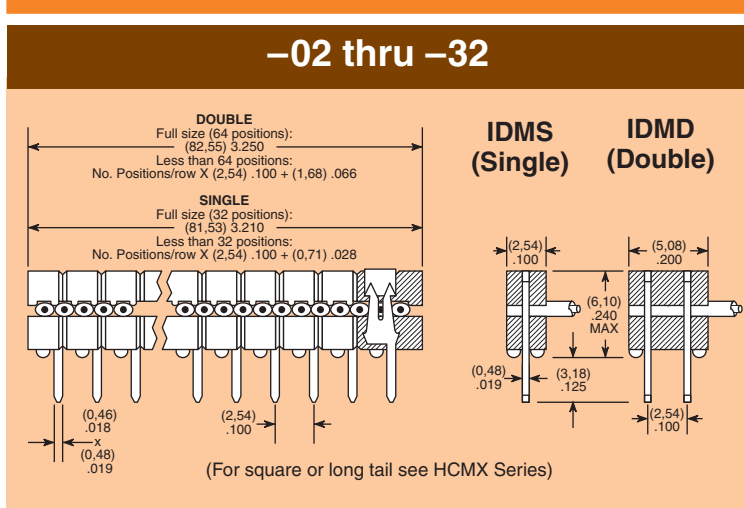
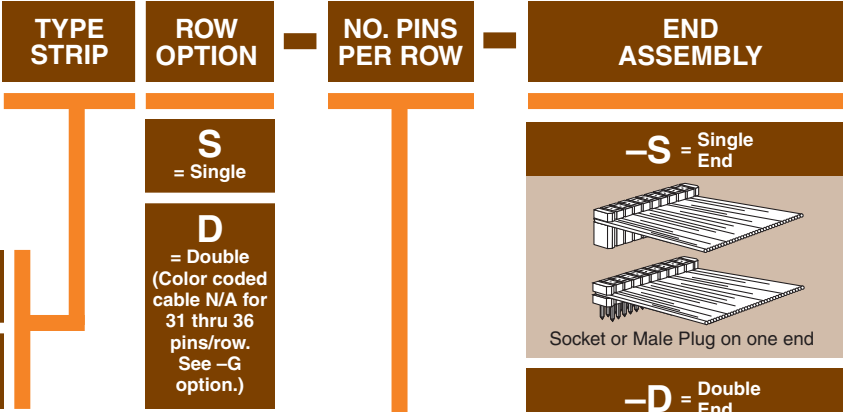

EJECTOR HEADERS & LOCKING CLIPS

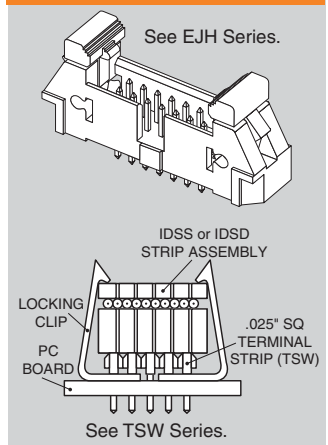

Due to technical progress, all designs, specifications and components are subject to change without notice.

WWW.SAMTEC.COM

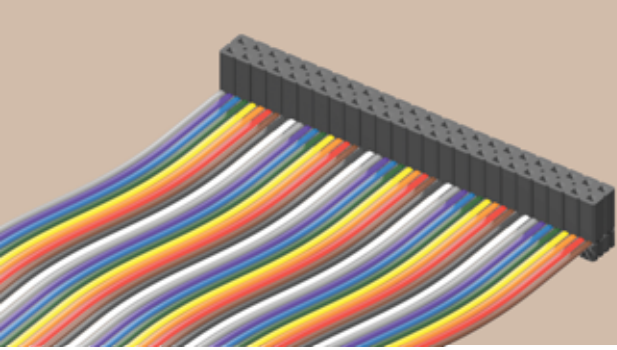

IDSD-24-S-05.00

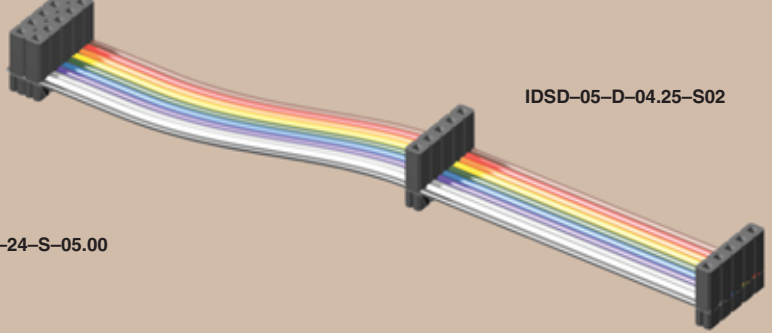

IDSD-05-D-04.25-S02

ASSEMBLED LENGTH

— “XX.XX”
= Assembled Length

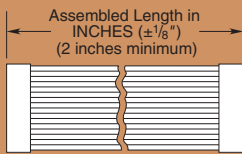

OPTION

POLARIZING KEY

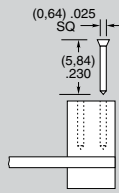

Optional polarizing key for use with IDSS & IDSD Series. Also polarizes SSW, SSQ, ESW & ESQ Series. Black High Temperature Thermoplastic

Order: Part Number PK-01-06
(Available in wheels of six each)

ALSO AVAILABLE

Molded-To-Position IDC Assemblies

- Low Profile
 - Skinny side locks
 - Dual beam contacts
 - Single and double row
 - (6,35mm) .025" square and (5,84mm) .230" length tail available
- Call Samtec for HCXX Series.

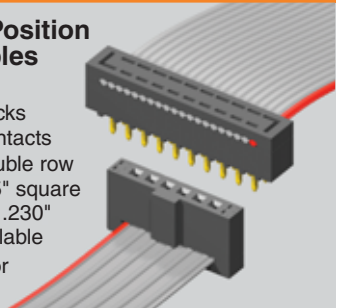

—T = Tin Plating
(Both ends)

—C = Tin IDM
= 10 μ m (0,25 μ m) Gold IDS
(-T End Assembly Required)

—A = 10 μ m (0,25 μ m) Gold IDM
= Tin IDS
(-T End Assembly Required)

Standard plating is selective gold over BeCu contact for IDS; Selective gold over phosphor bronze for IDM.

1

—ST “X”
= Stripped & Tinned

Specify Suffix from table.
All dimensions are $\pm 1/16"$.
Not available in 28 positions and higher.

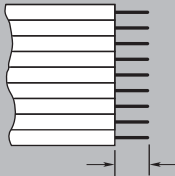

4

—S “XX”
= Daisy Chain Single

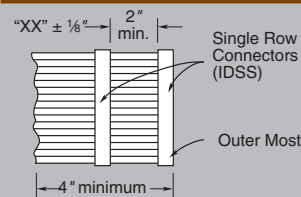

When mating double row connector with two single row connectors, the outer most single will be connected to Conductor #1 and the inside single to Conductor #2.

7

—R
= Reversed

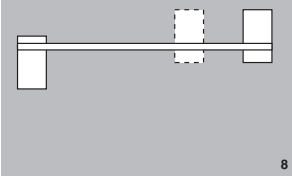

8

—P “XX”
= Polarized

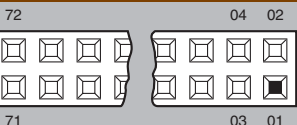

Specify “XX” as position. For Double the same position will be polarized on both ends. (Not available on IDM or EDM, unless transfer, then only the socket is polarized.)

2

—G
= Gray Cable

Specify -G for Gray cable. Gray cable has one red edge. IDSS and IDMS uses .100" centerline cable. IDSD and IDMD uses .050" centerline cable. Cable is 28 AWG 7/36 copper wire. Standard cable is same as above except color coded.

3

—B “XX”
= Breakout

Specify “XX” as number of conductors to be broken out.

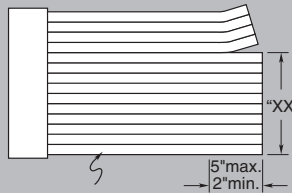

Breakout starts with Number 1 lead indicated by brown wire or red stripe. Shown on top side.

5

—D “XX”
= Daisy Chain, Double

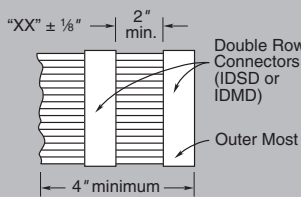

7

—W “XX”
= Wiring Reversed
Daisy Chain, Single

Same as -S “XX” except outer strip connected to Conductor #2 and inside strip connected to Conductor #1.

7

—M
= Middle Reversed

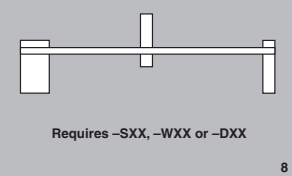

8

—O
= Outside Reversed

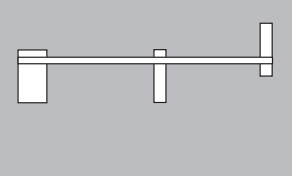

8

—RW
= Reversed Wiring

#1 wire opposite position #1.

6

Due to technical progress, all designs, specifications and components are subject to change without notice.

WWW.SAMTEC.COM