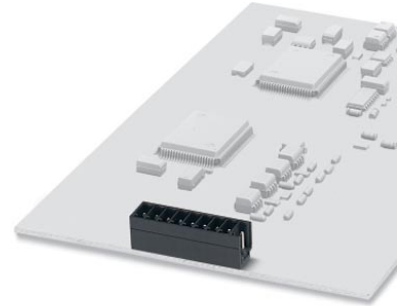

MCV 1,5/ 8-GR-3,5 THT

Order No.: 1961863

The illustration shows a 9-position version

<http://eshop.phoenixcontact.de/phoenix/treeViewClick.do?UID=1961863>

Header, Nominal current: 8 A, Rated voltage (III/2): 160 V, Number of positions: 8, Pitch: 3.5 mm, Color: Black, Assembly: SMD/THT/THR, Two-in-one – Pin strips must always be made up of a left (L) and a right (R) segment. Please allow for the corresponding counterpart from the accessories to complete the THR pin strip. User information and design recommendations on Through Hole Reflow Technology can be found at: <http://www.combicon.com>.

Commercial data

GTIN (EAN)	 4 017918 916183
Note	Made-to-order
sales group	E171
Pack	50 pcs.
Customs tariff	85366990
Catalog page information	Page 97 (CC-2005)

Product notes

WEEE/RoHS-compliant since:
01/01/2003

<http://www.download.phoenixcontact.com>
Please note that the data given here has been taken from the online catalog. For comprehensive information and data, please refer to the user documentation. The General Terms and Conditions of Use apply to Internet downloads.

Certificates / Approvals



Certification CUL, UL

Accessories

Item	Designation	Description
------	-------------	-------------

Marking

1954359	CP-MSTB NAT HT	Keying profile, prior to reflow soldering it is inserted in the groove on the connector and header, made from high-temperature-resistant beige insulation material
0804109	SK 3,81/2,8:FORTL.ZAHLEN	Marker card, printed horizontally, self-adhesive, 10-section marker strip, 14 identical decades marked 1-10, 11-20 etc. up to 91-(99)100, sufficient for 140 terminal blocks
0804109	SK 3,81/2,8:FORTL.ZAHLEN	Marker card, printed horizontally, self-adhesive, 10-section marker strip, 14 identical decades marked 1-10, 11-20 etc. up to 91-(99)100, sufficient for 140 terminal blocks

Plug/Adapter

1734634	CP-MSTB	Keying profile, is inserted into the slot on the plug or inverted header, red insulating material
---------	---------	---

Diagrams/Drawings

Drilling plan/solder pad geometry

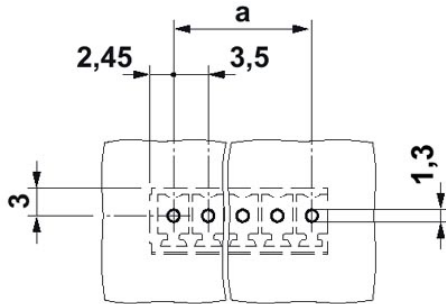

Dimensioned drawing

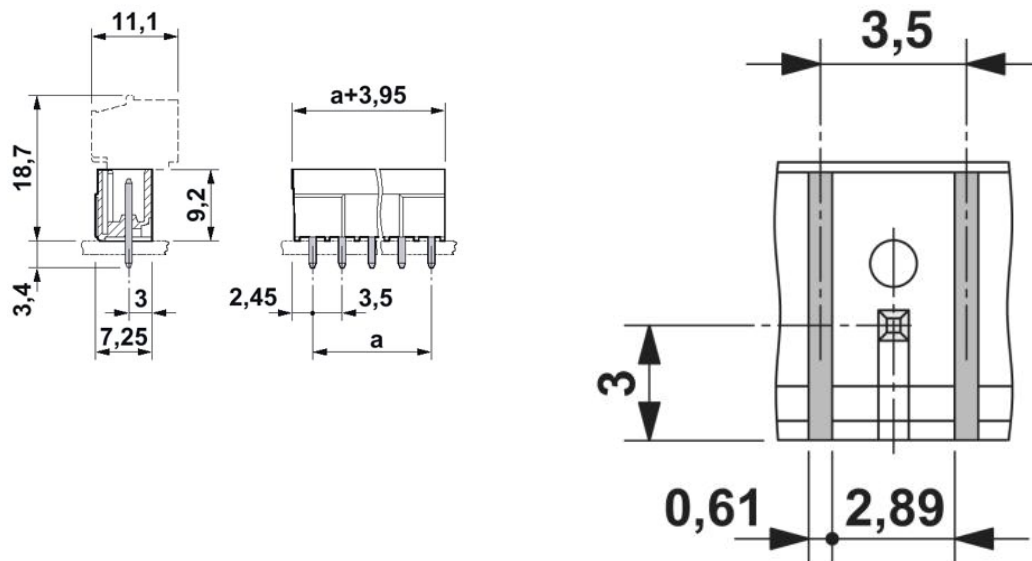

Address

PHOENIX CONTACT Inc., USA
586 Fulling Mill Road
Middletown, PA 17057, USA
Phone (800) 888-7388
Fax (717) 944-1625
<http://www.phoenixcon.com>



© 2011 Phoenix Contact
Technical modifications reserved;