

NO.	MASSE / DIMENSION
A	39.9
B	1 3/16-18UNEF-2A
C	61
D	21.9
E	29
F	9.4

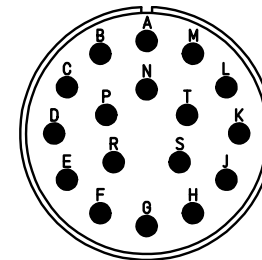
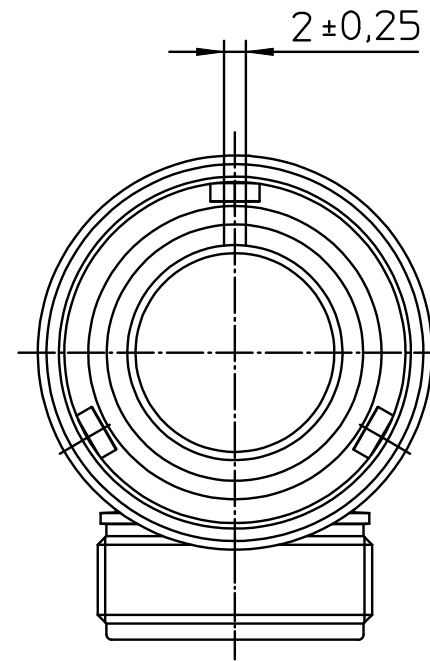
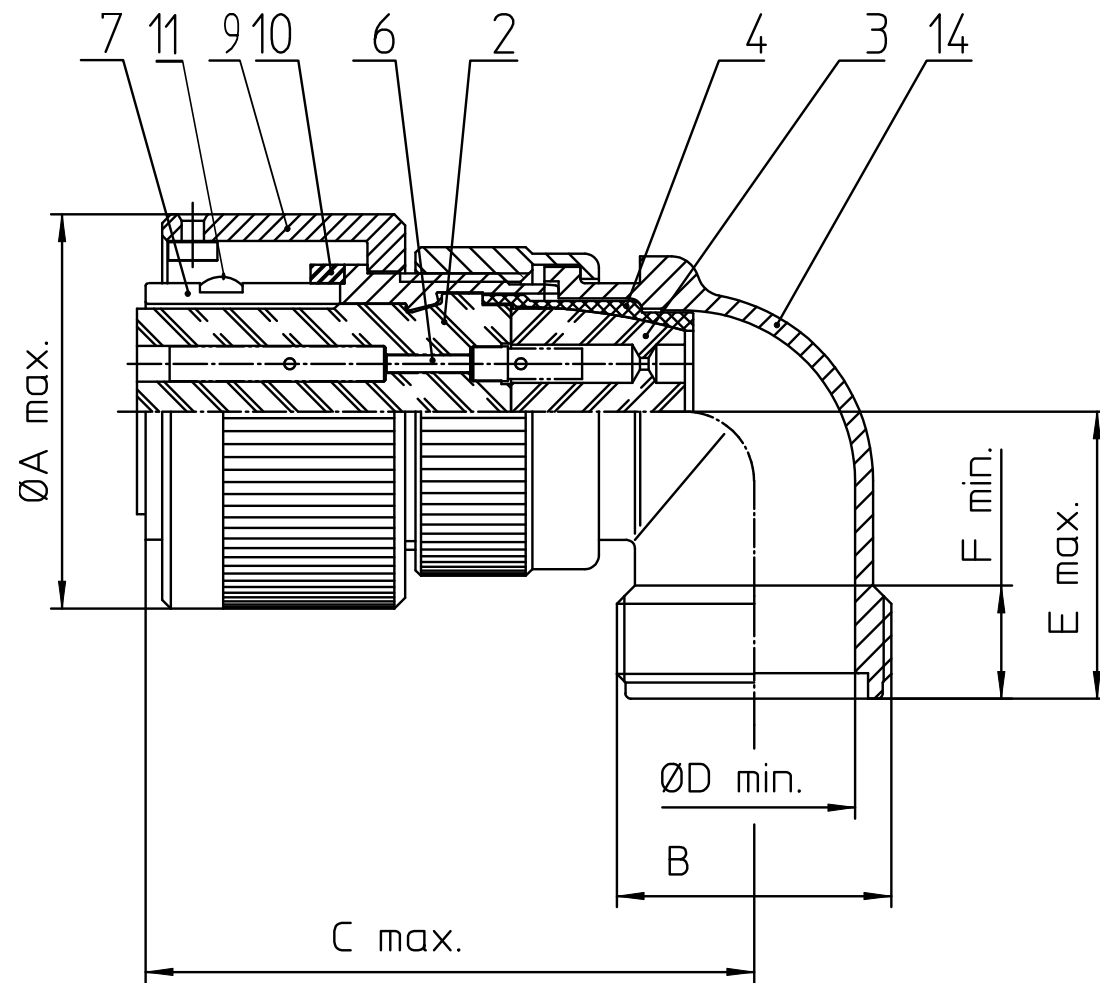

NO.	BESCHREIBUNG / DESCRIPTION
2	ISOLIERKÖRPER BUCHSE / INSULATOR SOCKET
3	DICHTKÖRPER / GROMMET
4	ENDRING / ENDRING
6	KONTAKTBUCHSE / CONTACT SOCKET
7	ZYLINDERGHÄUSE / BARREL
9	ÜBERWURFMUTTER / COUPLING NUT
10	DICHTRING FRONT / FRONT SEALING RING
11	SCHIRMKRANZ/SHIELDING BRAID
14	F-ENDGEHÄUSE / F-ENDBELL

Note: Due to an automatic nomenclature system, numbers generated may not be sequential.
 Specification and Dimensions subject to change
 Drawings illustrate normal insulator positioning

Material Specification:	
Shell Material:	Aluminium alloy
Shell Plating:	Olive drab chromate over cadmium (conductive)
Insulator Material:	CR-Elastomere
Contact Material:	Copper alloy
Contact Plating:	Hard silver

all dimensions are in mm
 Dimensions without tolerance indications are general tolerances in acc. with DIN7168m

drawing for
 CUSTOMER



description CA3108F20-29S-B-15
 Plug, 90° shielded
 Shielded with endbell for shielded braids & heat shrinkable boots
 AWG Crimp / Socket / Layout: 20-29